

**NOVOHALL
Transducer
5 up to 50 mm
touchless**

Series TFD-4000

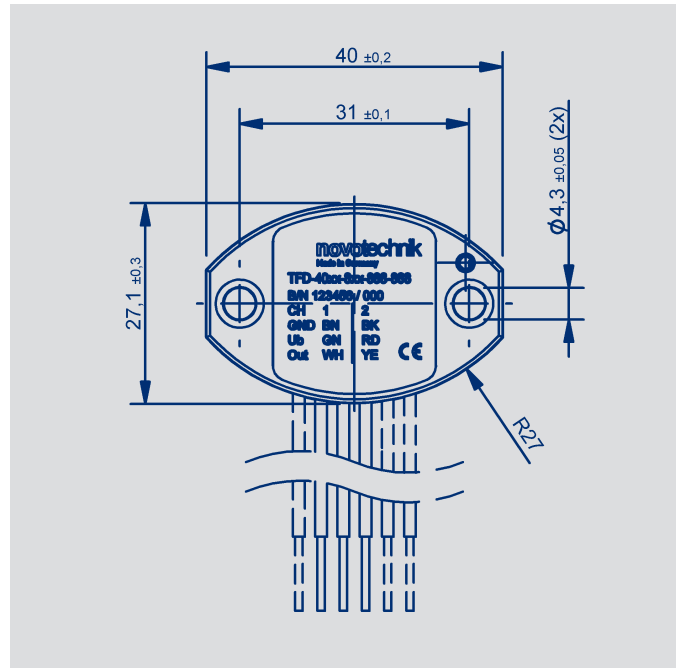
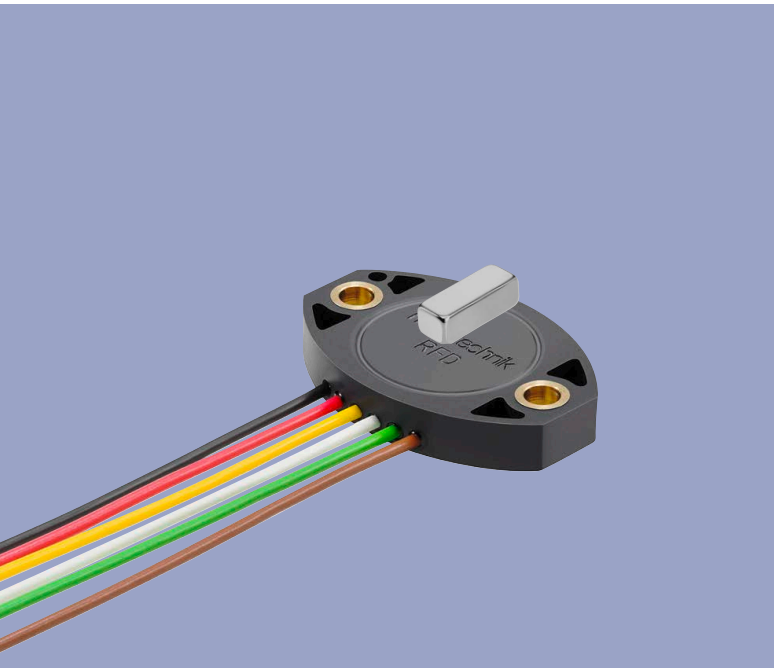

Special features

- Hall technology
- 2-part, mechanically decoupled
- High protection class, IP67, IP68, IP69
- Resolution up to 12 bit
- Wear-free
- Temperature range -40 °C up to +125 °C
- Single and redundant versions
- Optimized for mechanical engineering and mobile applications
- Favourable price / performance ratio
- Extremely flat design
- Customized versions

Project item

Please contact your local distributor or our technical support
Phone (+49) 711 4489-250
support@novotechnik.de

Applications

- Mechanical engineering
 - Textile machinery
 - Packaging machinery
 - Sheet metal and wire working machinery
- Medical applications
- Mobile machinery
 - Industrial trucks
 - Construction machinery
 - Agricultural and forestry machinery
 - Railway technology
- Navy applications

Contents

Dimension drawing	3
Mechanical data	4
Output characteristics	5
Analog versions	
Technical data	6
Ordering specifications	7
Accessories	
Position markers	8
Signal processing	9
Customized versions	
Connecting options	10

Dimension Drawing

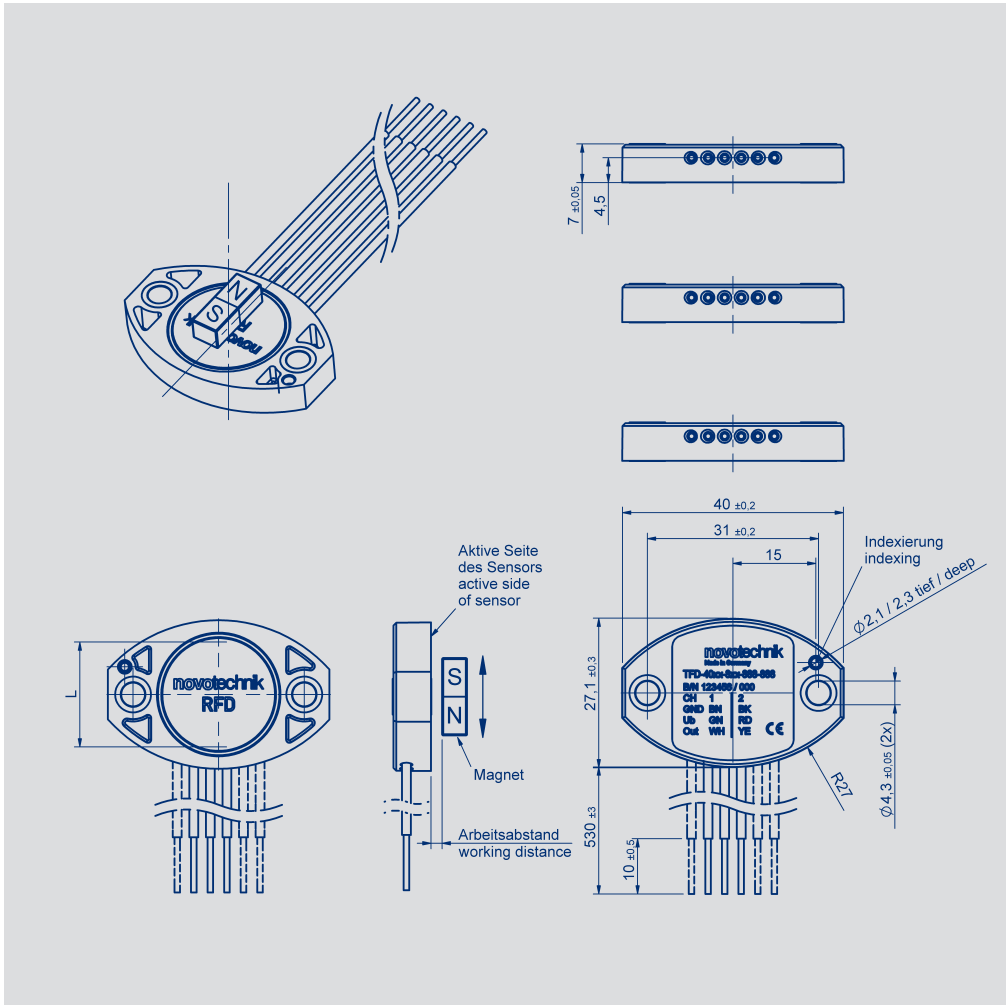

CAD data see
www.novotechnik.de/en/download/cad-data/

Magnet alignment

The north pole of the magnet (color marking) must show in direction of the electrical connection.

If the magnet is located centrally to the sensor, the sensor is near the electrical center position.

Characteristic directions

Signal channel 1 rising, signal channel 2 falling when moving away from electrical connection.

Mechanical Data

Description		
Housing	High grade, temperature resistant plastic, Thermoplast with brass inserts	
Electrical connections	Lead wires, 0.5 mm ² (AWG 20), PVC insulated	
Mechanical Data		
Dimensions	See dimension drawing	
Mounting	2 round-head screws with hexagon socket M4x14 (included in delivery)	
Fastening torque of mounting screws	200 ... 300	Ncm
Maximum operational speed	Mechanically unlimited	
Weight (w/o connection)	approx. 10	g
Vibration (IEC 60068-2-6)	5 ... 2000 Amax = 0.75 amax = 20	Hz mm g
Shock (IEC 60068-2-27)	50 (6 ms)	g
Life	Mechanically unlimited	
Protection class (DIN EN 60529 / DIN 40050)	IP67 / IP68 / IP69	
Operating temperature	-40 ... +125	°C

Output Characteristics

One channel, rising

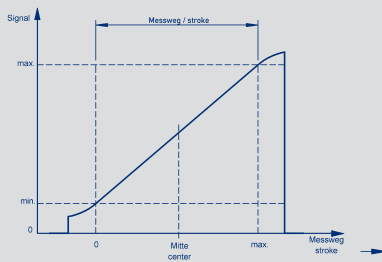

On request: one channel, falling

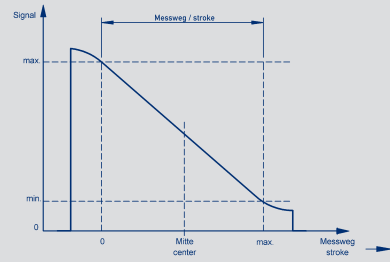

Crossed characteristics, channel 1 rising

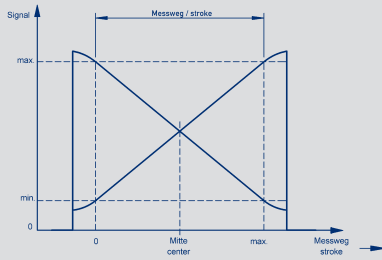

On request: two channels, signal 2 = 0.5 x signal 1

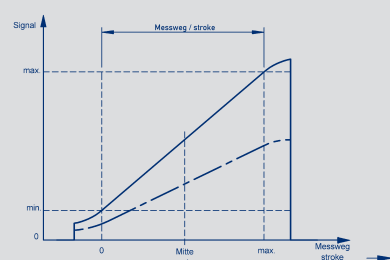

On request: Trapeze characteristic

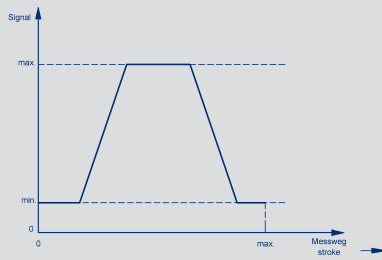

On request: different gradients

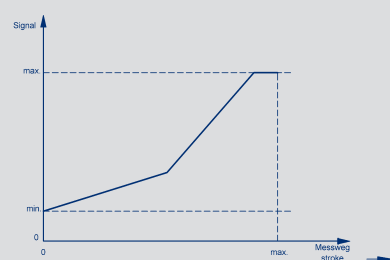

On request: Parable characteristic

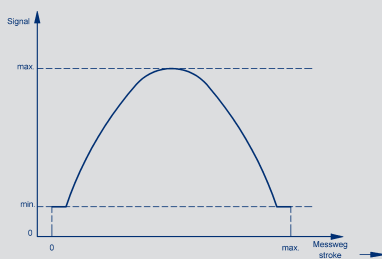

Technical Data

Technical Data		
Type designations	TFD-4021- _ _ _ - 2 _ _ - _ _ _ ratiometric	
Electrical Data		
Supply voltage U_b	5 (4.5 ... 5.5)	VDC
Current consumption (w/o load)	typical 15 (typical 8 on request) per channel	mA
Reverse voltage	yes, supply lines	
Short circuit protection	yes, all outputs vs. GND and supply voltage	
Measuring range (dimension L)	standard 14 and 24, other lengths from 5 up to 50 mm on request	mm
Number of channels	1 / 2	
Update rate	typical 2.5	kHz
Resolution	12	bit
Repeatability	≤ 0.1	$\pm\%$ FS
Hysteresis	≤ 0.1	$\pm\%$ FS
Output signal	ratiometric to supply voltage 5 ... 95 % (0.25 ... 4.75 V at 5 V) (load ≥ 10 k Ω)	
Temperature error	≤ 0.5	$\pm\%$ FS
Insulation resistance (500 VDC)	≥ 10	M Ω
Environmental Data		
MTTF (DIN EN ISO 13849-1 parts count method, w/o load, wc)	675 (single channel) 512 (per channel) partly redundant 516 (per channel) fully redundant	years years years
Functional Safety	If you need assistance in using our products in safety-related systems, please contact us	
EMC compatibility	ISO 11452-2 Radiated EM HF-Fields, Absorber Hall: 100 V/m ISO 11452-5 Radiated EM HF-Fields, Stripline 200 V/m ISO TR10605 Packaging und Handling + Component Test: 8 kV, 15 kV CISPR 25 Radiated Emission (conducted / field) class 5 EN 61000-4-4 fast transients (burst) EN 61000-4-6 conducted disturbances, induced by RF fields EN 61000-4-8 power frequency magnetic fields	



Connection assignment			
Colour	single channel code 6 _ _	partly redundant code 7 _ _	fully redundant code 8 _ _
GN	Supply voltage U_b	Supply voltage U_b	Supply voltage U_b 1
BN	GND	GND	GND 1
WH	Signal output	Signal output 1	Signal output 1
RD	_	-	Supply voltage U_b 2
BK	_	-	GND 2
YE	_	Signal output 2	Signal output 2

Ordering Specifications Analog Versions

Ordering specifications

Preferred types printed in bold

Supply voltage U_b
2: 5 V (4.5 ... 5.5 V)

Output signal

1: 0.25 ... 4.75 V ratiometric to supply voltage
Other signal levels on request

Output characteristic

1: Rising
3: Crossed output channel 1 rising (partly redundant)
4: Crossed output channel 1 rising (fully redundant)
Other characteristics on request

Electrical connections

401: Lead wires 3 x L = 0.5 m, single
411: Lead wires 4 x L = 0.5 m, partly redundant
421: Lead wires 6 x L = 0.5 m, fully redundant
Other lengths and assembled connectors on request

T F D - **4 0 2 1** - **6 2 4** - **2 1 1** - **4 0 1**

Series

Mechanical specification
4021: Standard

Electrical measuring range

14: 14 mm
24: 24 mm
Other lengths from 5 up to 50 mm on request

Number of channels

6: single channel 1 x U_b / 1 x output
7: partly redundant 1 x U_b / 2 x output
8: fully redundant 2 x U_b / 2 x output

Position markers

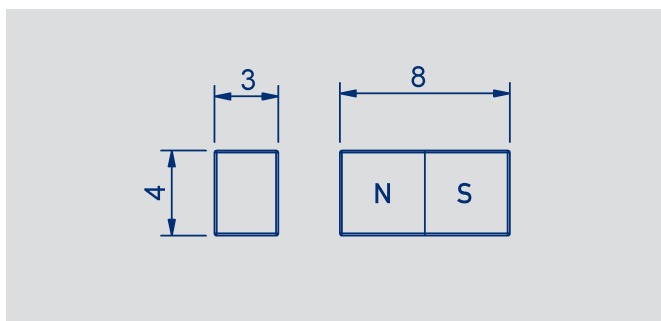
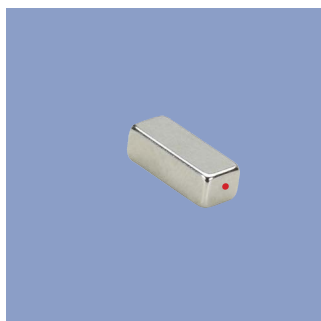

Z-TFC-P03

Magnet for direct application

- for measuring range 8 ... 14 mm
- working distance
 - single 0.7 ± 0.5 mm
 - redundant $0.3 + 0.5$ mm / -0.3 mm
- max. permitted offset parallel to the sensing direction ± 1 mm
- P/N 104225

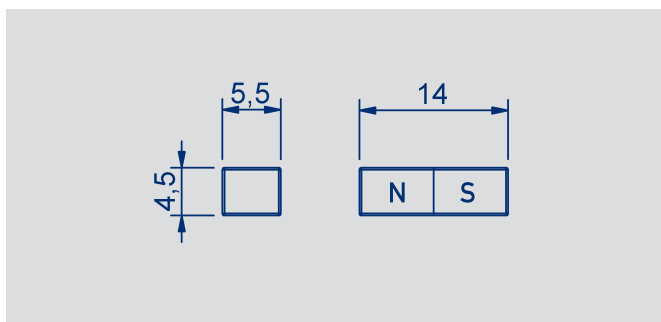
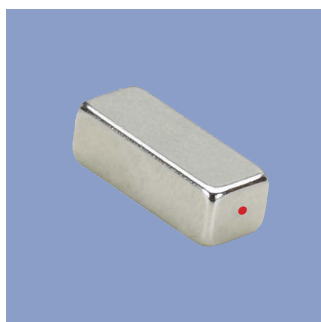

Z-TFC-P04

Magnet for direct application

- for measuring range 15 ... 24 mm
- working distance
 - single 2.5 ± 0.9 mm
 - redundant 2.0 ± 0.9 mm
- max. permitted offset parallel to the sensing direction ± 1 mm
- P/N 104226

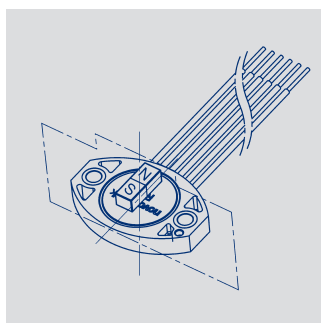

Important instructions for magnet installation

The accuracy of linear magnetic sensors is strongly influenced by the installation space. Using the latest simulation tools, we are able to design the measurement system optimally for your application. In order to select the best suitable magnet for your requirements please contact us.

Between magnet / sensor unit and surrounding magnetic or magnetizable materials a minimum distance of 12 mm must be ensured. If this is not possible, the accuracy of the system will be affected and the data have to be verified.

**Multifunctional
Measuring Device
with Display
Series MAP-4000**

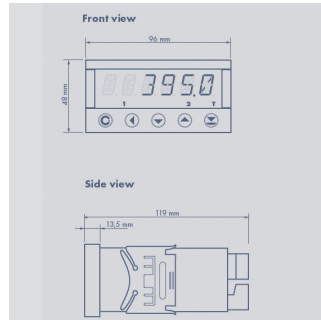

Special features

- Supply voltage 10 ... 30 VDC, 80 ... 250 V DC or AC
- high accuracy
- direct connection of potentiometric and standardized signals
- adjustable supply voltage for sensors 5 ... 24 V
- Temperature coefficient 100 ppm/K
- optional RS 232, RS 485, analog output, limited switch
- complete data see separate data sheet MAP-4000

Ordering specifications

Number comparator relays

- 0: none
- 2: 2 relays
- 4: 4 relays

Analog output

- 0: no analog output
- 1: analog output present

Interface

- 0: no interface
- 1: RS 232
- 2: RS 485

M A P - 4 0 1 0 - 0 0 0 - 1 0 1

Series

Supply voltage

- 00: 10 ... 30 V AC/DC
- 10: 80 ... 250 V AC

Adjustable supply voltage (5 ... 24 V/Max. 1,2 W)

- 1: with supply voltage

Display colour

- 1: red

Data storage (only with interface)

- 0: not storage
- 1: RTC storage
- 2: FAST storage



Connecting Options on request



Tyco AMP Super Seal

- Pin- and bushing housing
- Customized lengths
- 3-, 4- and 6-pol. versions
- Protection class IP67
- on request



Deutsch DTM 04

- Pin- and bushing housing
- Customized lengths
- 3-, 4- and 6-pol. versions
- Protection class IP67
- on request

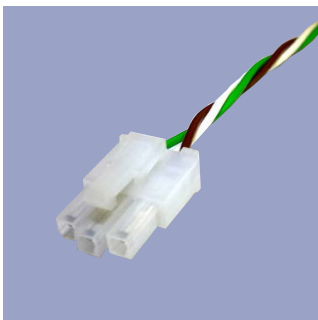

Molex Mini Fit jr.

- Customized length and lead wires
- 3-, 4- and 6-pol. versions
- on request



Molex Mini Fit

- Customized length and lead wires
- 3-, 4-, 6- and 8-pol. versions
- on request

The specifications contained in our datasheets are intended solely for informational purposes. The documented specification values are based on ideal operational and environmental conditions and can vary significantly depending on the actual customer application. Using our products at or close to one or more of the specified performance ranges can lead to limitations regarding other performance parameters. It is therefore necessary that the end user verifies relevant performance parameters in the intended application. We reserve the right to change product specifications without notice.